

Article number: 0106050

Description: Retaining ring JV 33

## Measures

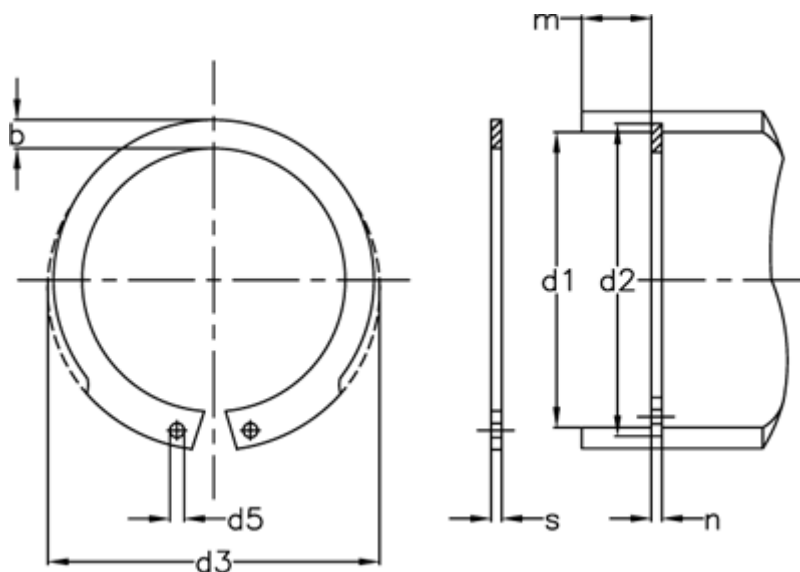

AN mm <sup>2</sup>	= 44	FRg kN	= 4.8	tol	= 0.1
b	= 3.3	FR kN	= 13.8	tol	= -0.06
d1	= 33	g	= 1.0	tol	= +0,50-0,25
d2	= 34.7	K kN-mm	= 26.6	tol	= +0,25
d3	= 35.5	m min	= 1.30	Tong	= ZGJ-1
d5 min	= 1.5	Nominal drive	= 3.0	Weight kg/1000	= 2.35
Description	= JV 33	s	= 1.20		
FN kN	= 7.30	t	= 0.85		